

# COMMUNITY HELPERS

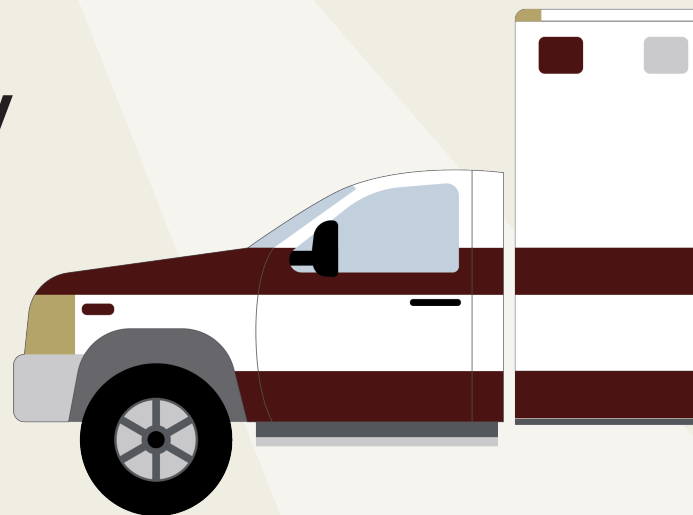

## WHO WORK IN YOUR CITY

Activity  
Book





# COMMUNITY HELPERS

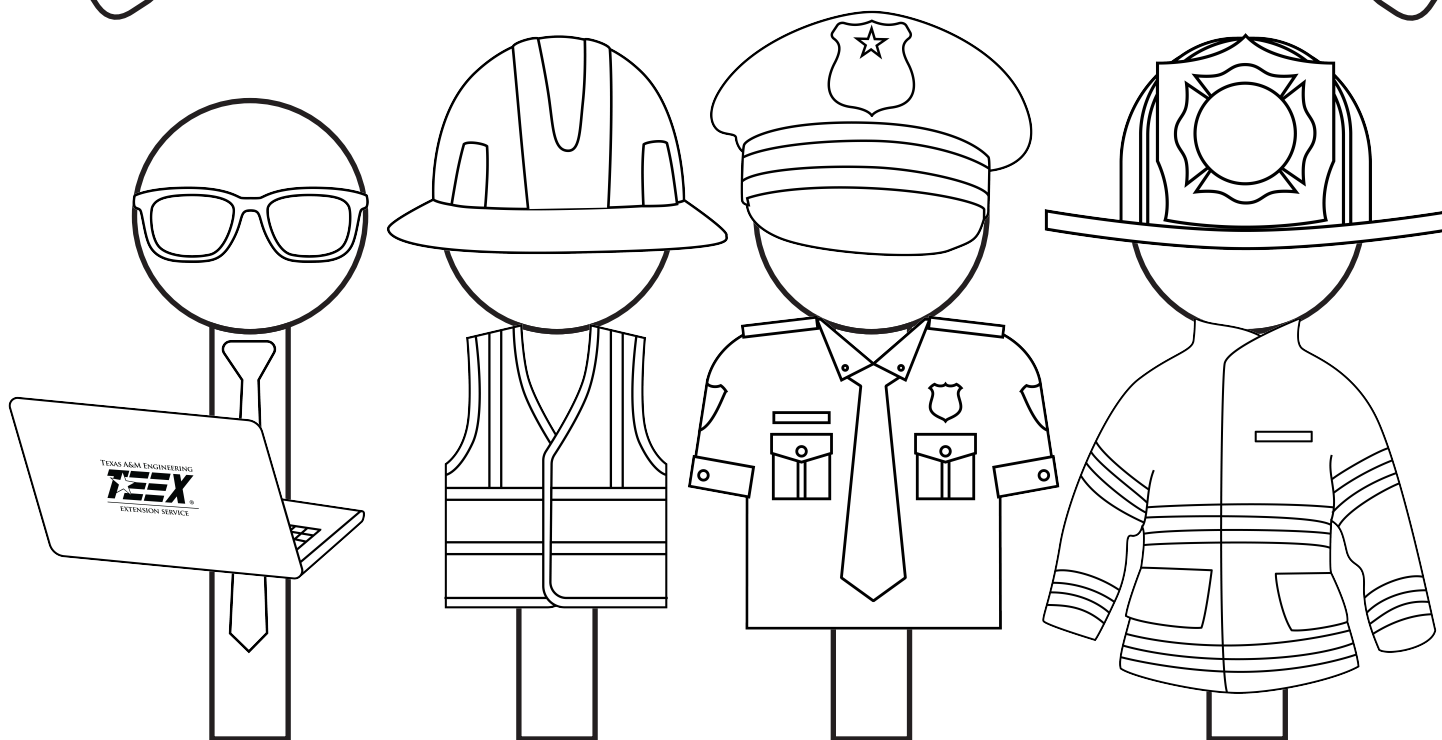

## WHO WORK IN YOUR CITY

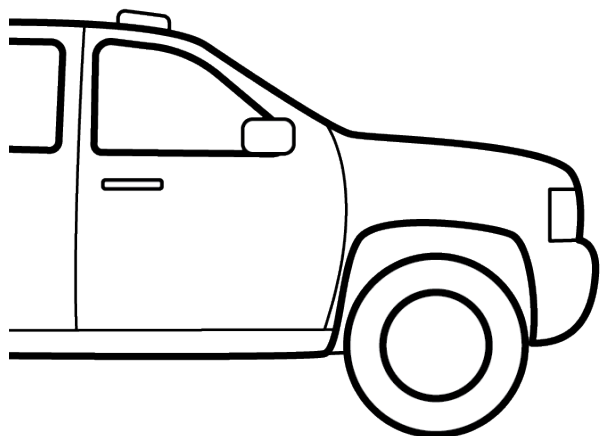

Activity  
Book

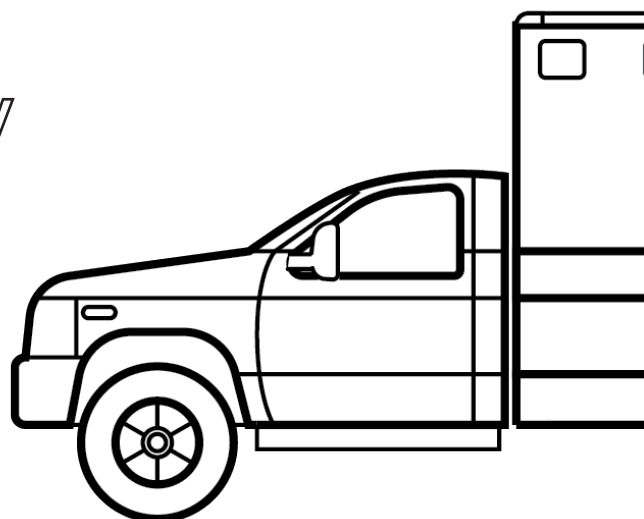



# Gear Up

Firemen, policemen, construction workers, and EMTs each need different types of gear and special vehicles to help their communities.

*Color this page and match the workers' gear with their correct vehicle.*

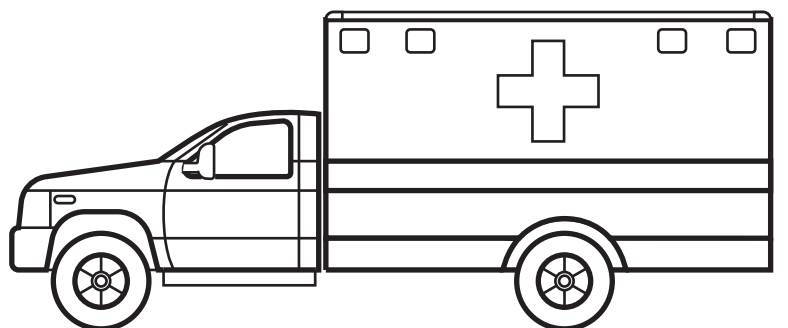
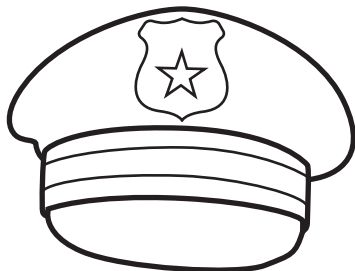
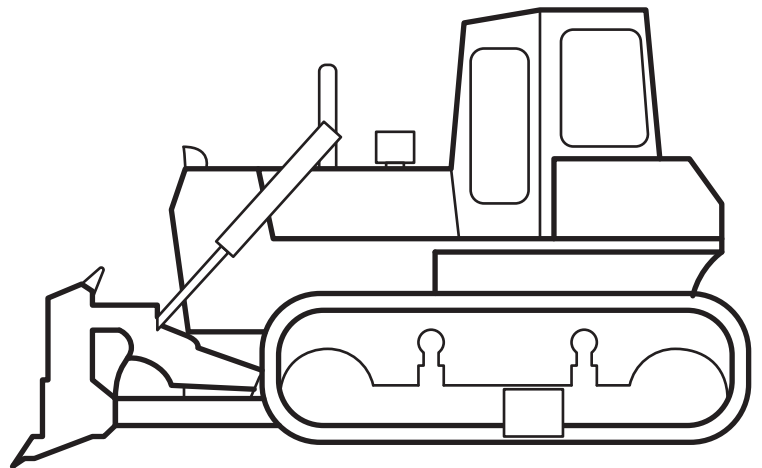
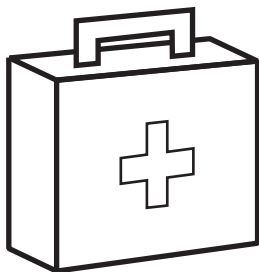
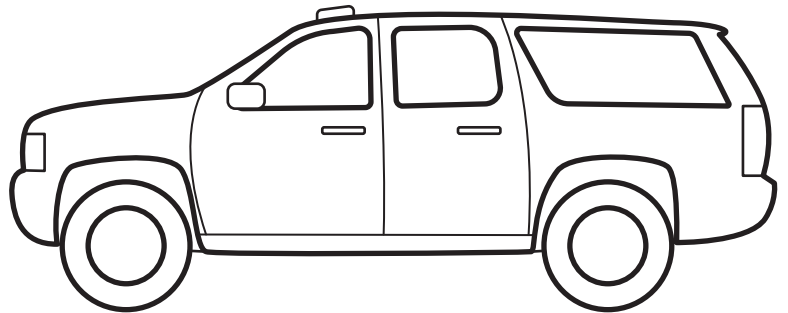
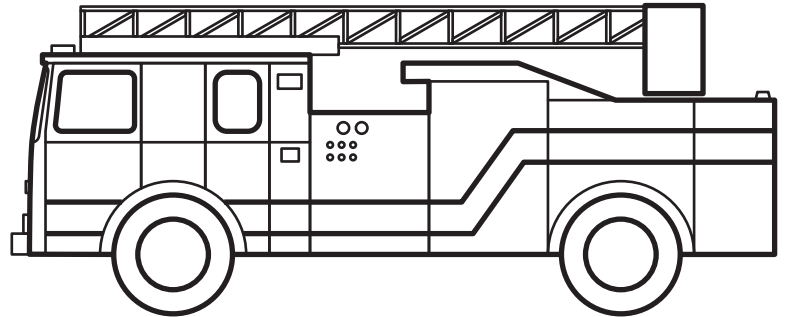
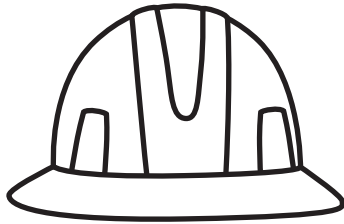

# To the Rescue

Emergency Medical Technicians (EMTs) drive ambulances to people who are hurt or in danger and help get them the medical attention they need.

*Help the EMTs driving this Ambulance reach the house with an injured patient.*

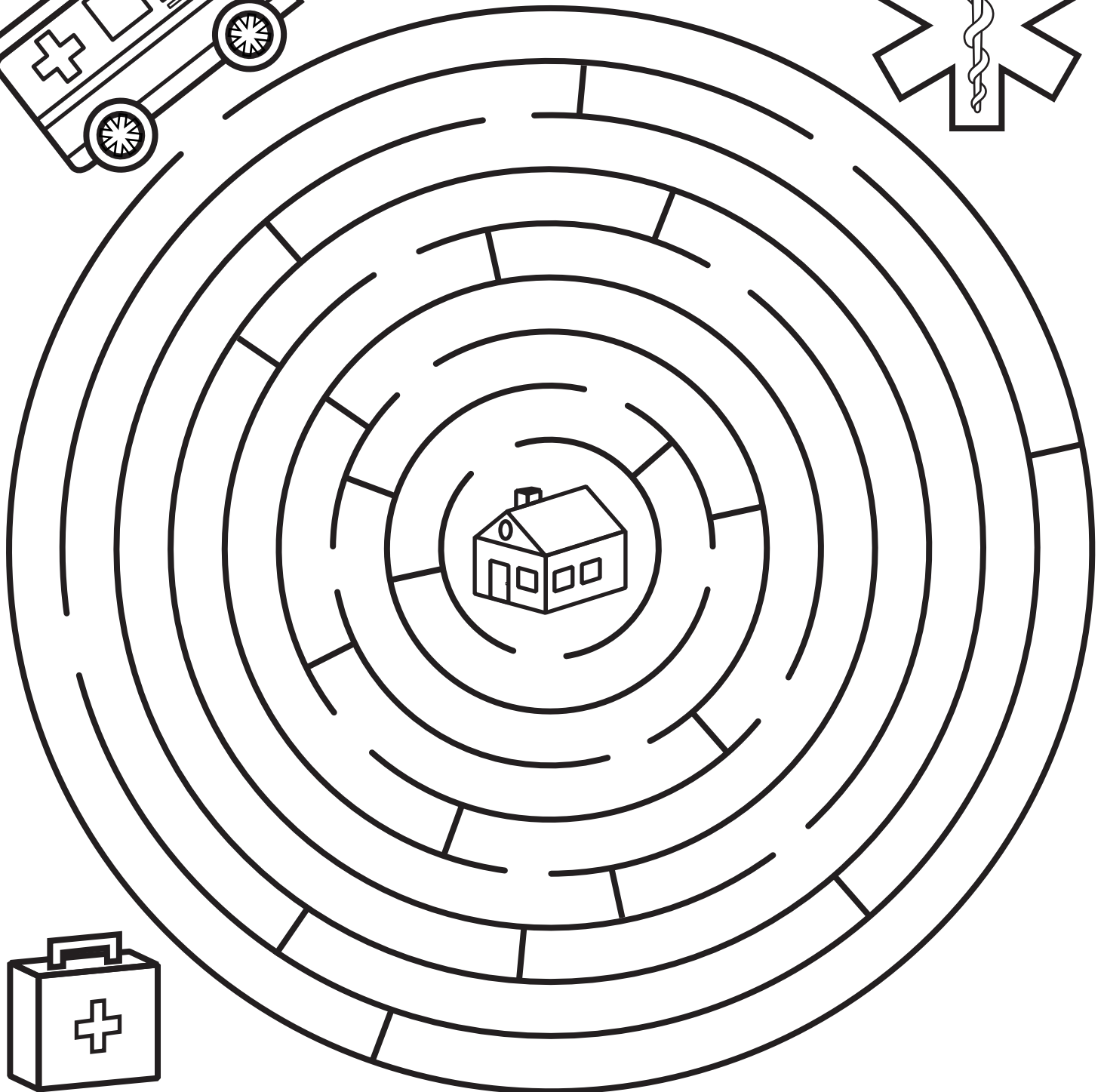
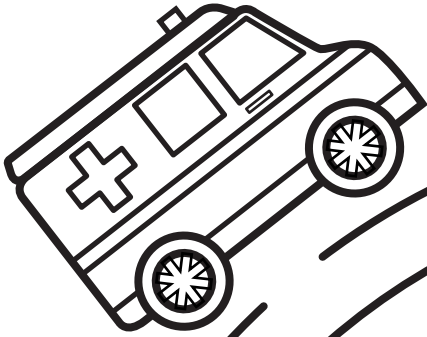

# Working Hard

Construction sites can be found all around your city. A safety professional is a person who is in charge of making sure all workers at a construction site do their job safely so no one gets hurt. TEEX shows safety professionals the rules to keep workers safe. *Color this construction site.*

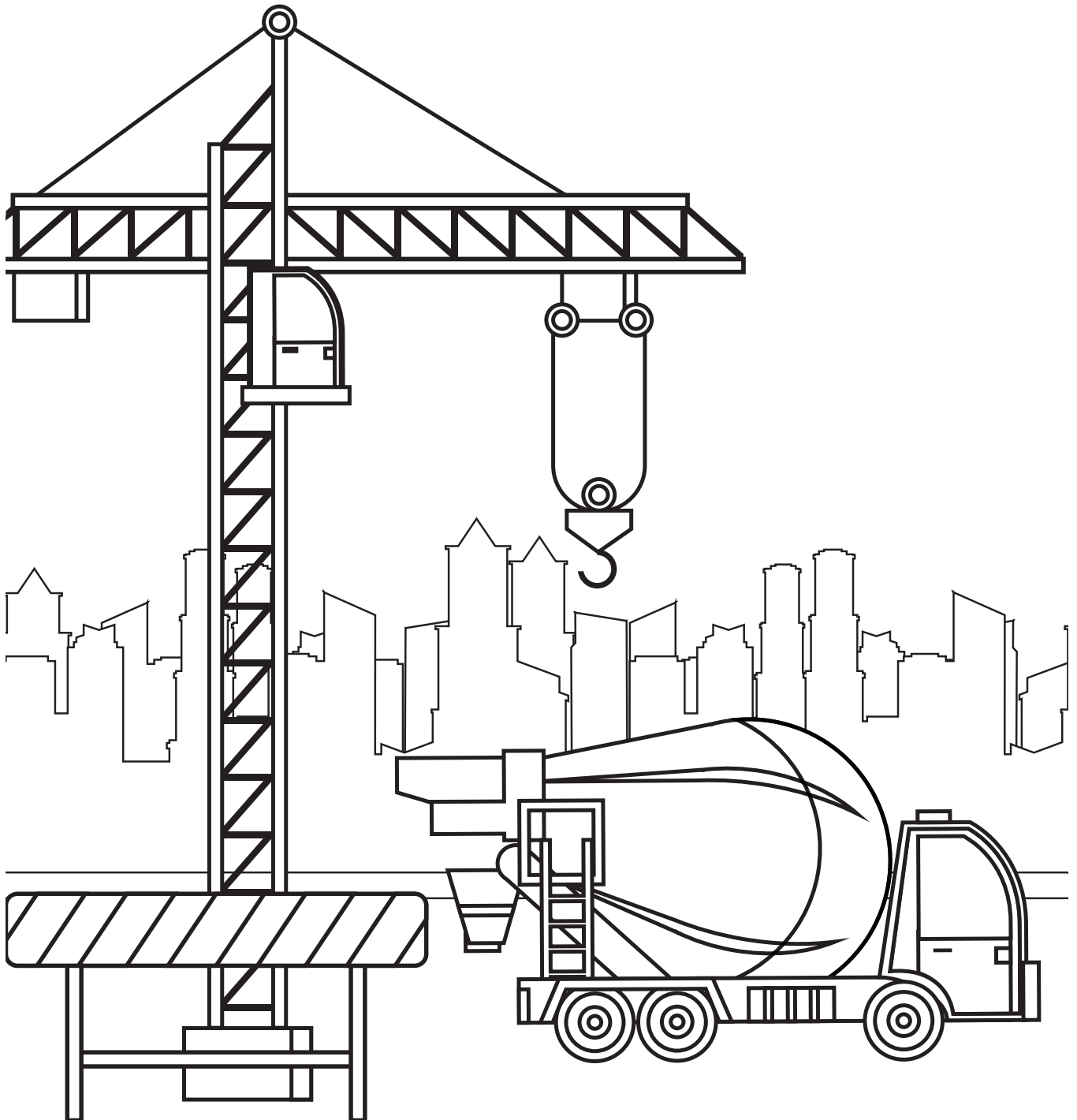

# Word Sleuth

Criminal Investigation is a type of science that involves finding fingerprints, footprints, blood, and other evidence at crime scenes that can help the investigator put the pieces together to solve a crime.

*Do some forensic work to discover these words.*



FINGERPRINT  
INK  
EVIDENCE  
PHOTO  
BLOOD  
HANDCUFFS  
SKULL  
SLEUTH  
FORENSIC  
INVESTIGATE  
CRIME  
GUN  
BULLETS  
SCENE  
DNA  
DETECTIVE

L	E	V	B	S	K	U	L	L	F	I	S
F	V	H	R	C	L	A	S	C	E	N	E
O	I	A	N	R	N	E	R	C	D	V	B
R	D	N	A	I	H	L	U	F	I	E	L
E	E	D	G	M	D	E	I	T	K	S	O
N	N	C	A	E	W	T	C	N	H	T	O
S	C	U	L	K	R	E	G	V	K	I	D
I	E	F	I	E	T	P	A	M	L	G	I
C	A	F	U	E	O	A	R	E	I	A	L
A	F	S	D	S	S	C	U	I	N	T	L
P	H	O	T	O	T	P	G	U	N	E	K
N	D	M	V	H	B	U	L	L	E	T	S





# Big Machines

Have you ever wondered how roads or bridges are built? What about buildings? Vehicles such as bulldozers, cranes, and dump trucks are used to move heavy objects, place beams on tall buildings, and move dirt from one place to a construction site. The people who use these vehicles are called heavy equipment operators. TEEX trains heavy equipment operators. It's what we do!

*Connect the dots on this equipment to see what kind of vehicle it is.*

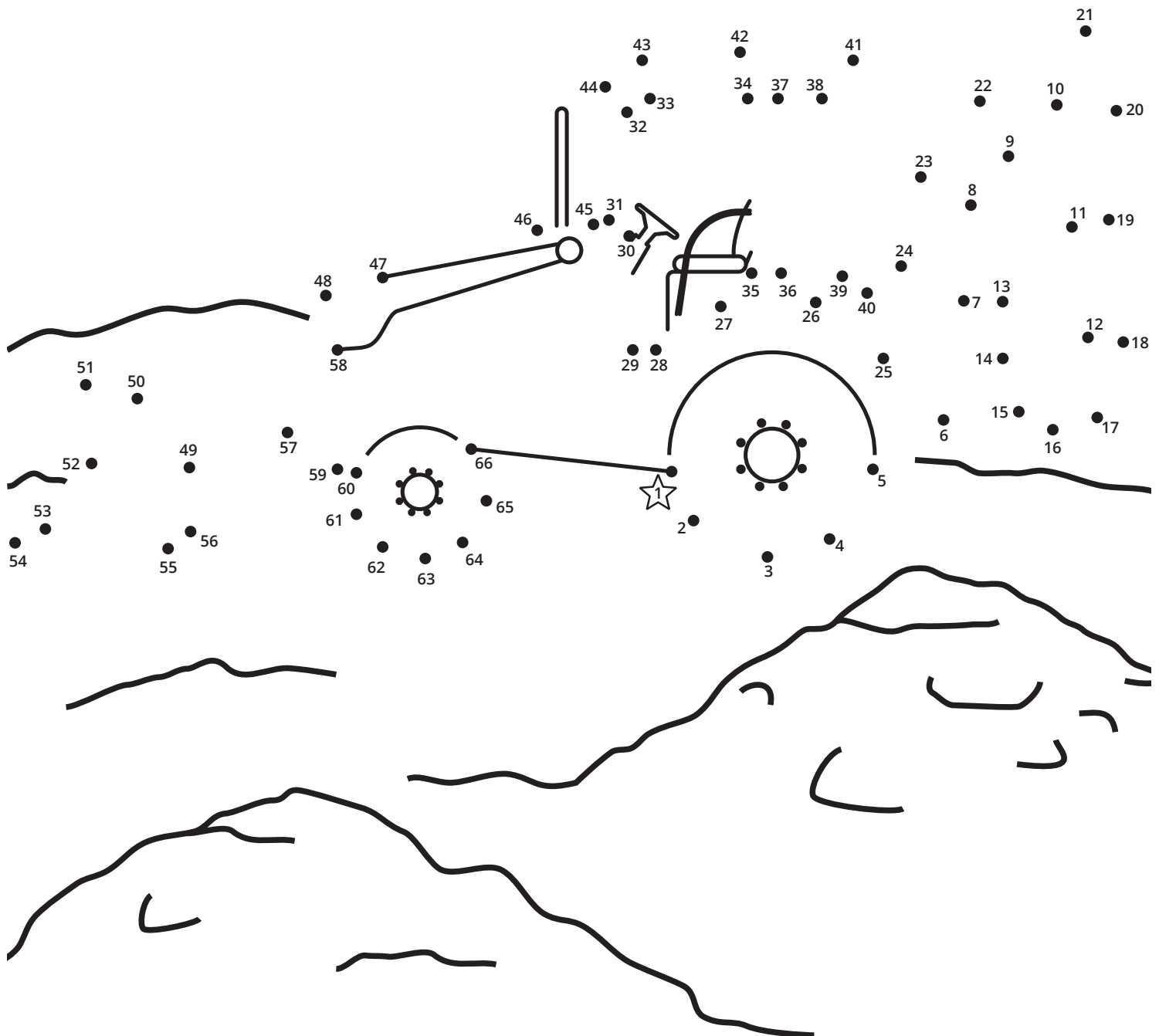

# Clean It Up

When we use water, it becomes dirty. Dirty water is cleaned through a process called wastewater treatment. When the water is cleaned, we can use it again. TEEX trains people who work in wastewater treatment plants.

*How many words can you make using the letters in "wastewater"?*

## WASTEWATER

_____	_____	_____
_____	_____	_____
_____	_____	_____
_____	_____	_____
_____	_____	_____
_____	_____	_____
_____	_____	_____
_____	_____	_____
_____	_____	_____
_____	_____	_____

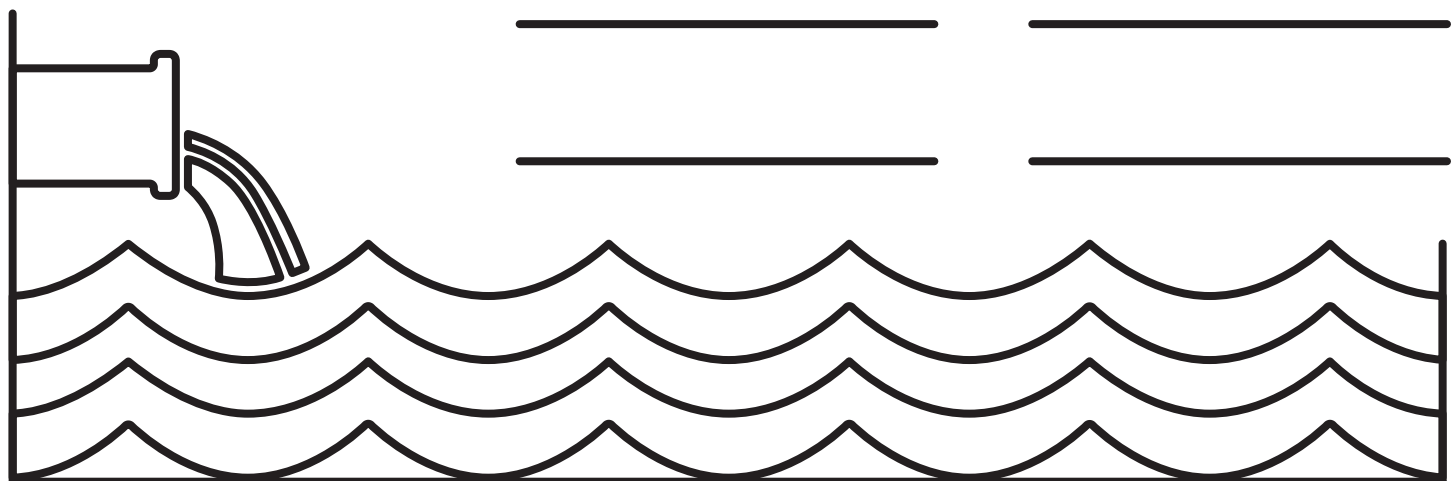

# Order in the Court

The Court Security Officer keeps order in the courtroom for the Judge and also makes sure everyone in the room is always safe. He or she helps people who are visiting the courthouse by answering their questions and helping them find the right courtrooms or offices.

*Color this court scene.*



# Hydration Station

You probably know that fire hydrants are used by firemen as a water source where they can connect their hoses. But did you also know that there are also people called water treatment workers who keep the fire hydrant water clean and safe in case a firefighter ever needs to use the hydrant?

*Draw a mirror of the left grid onto the right grid, completing the full fire hydrant image.*

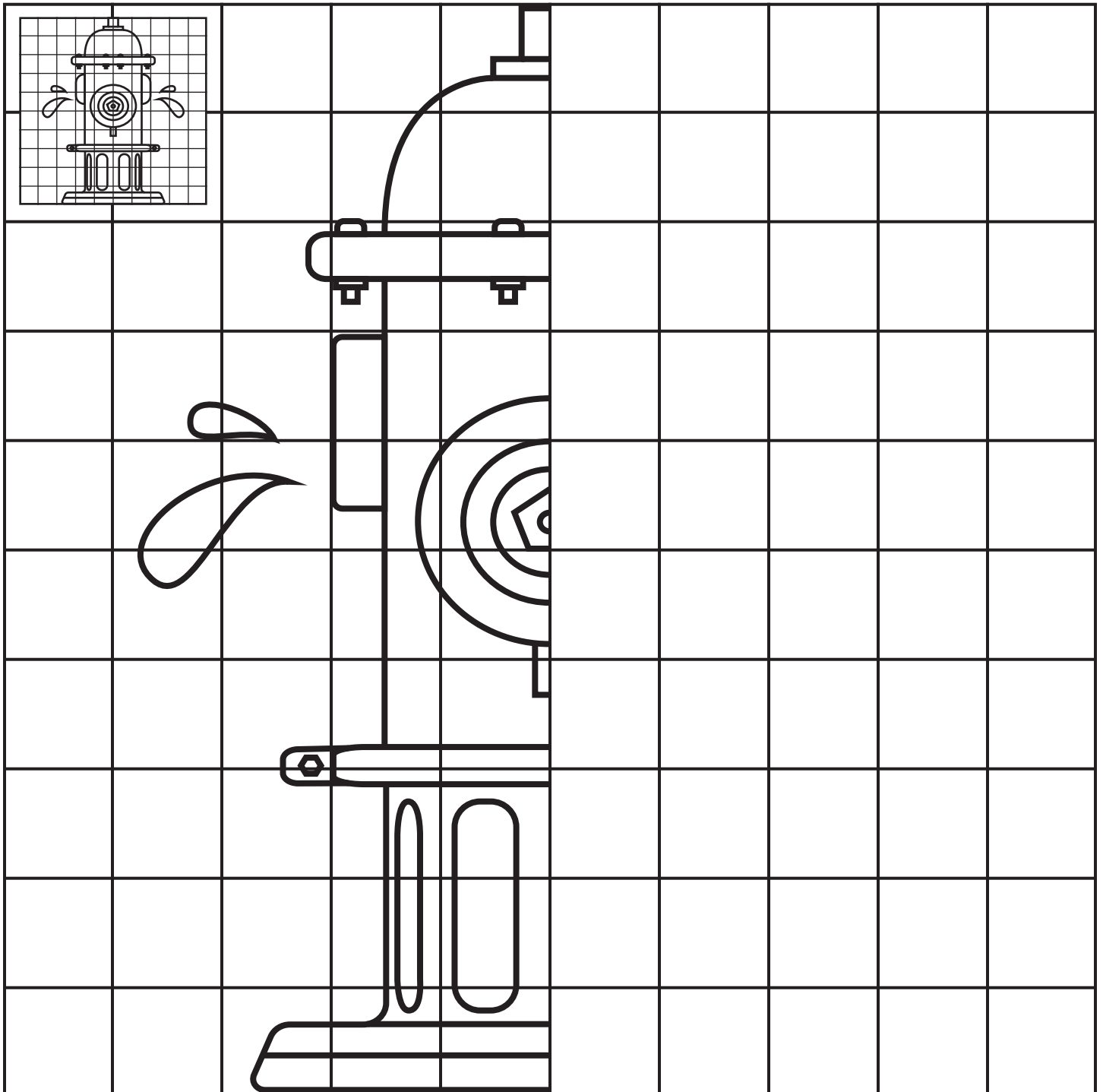

# Behind the Wheel

School bus drivers have one of the most important jobs on the planet! They make sure kids get to and from school safely. Did you know that TEEX trains school bus driver instructors for schools?

*Color this school bus picture and draw yourself as the driver.*

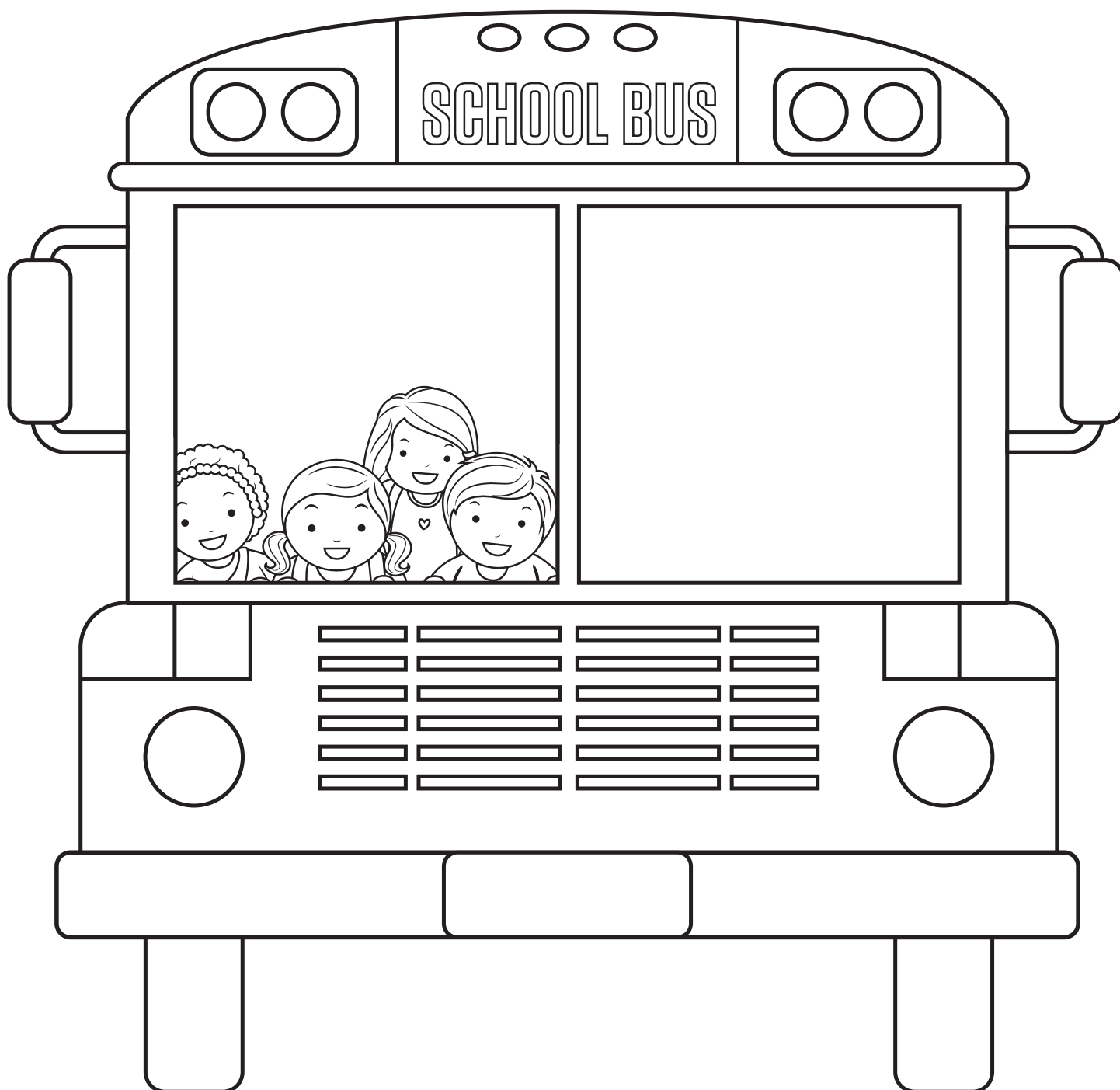

# Crack the Code

Internet-connected or cyber devices are everywhere—computers, cellphones, and TVs. Because almost everyone uses cyber devices, bad people will use them to steal money, information, or people’s identities! Always check with an adult before clicking on links or attachments from strangers.

*Can you decode these word jumbles.*

RESU \_\_\_\_\_

RCEKAH \_\_\_\_\_

DOEC \_\_\_\_\_

KATATC \_\_\_\_\_

ROUMPTEC \_\_\_\_\_

PAP \_\_\_\_\_

BRYEC \_\_\_\_\_

TAAD \_\_\_\_\_

VRUSI \_\_\_\_\_

NEOHP \_\_\_\_\_

*Use the decoder key to crack the code of these secret words.*

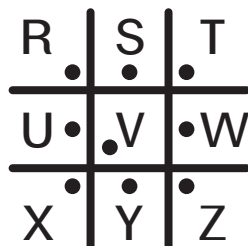
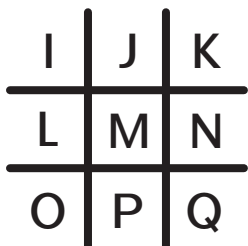
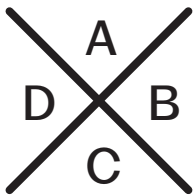

# Get Connected

Cybersecurity is protecting against criminals and unauthorized use of electronic data. Keep your personal information private when using the internet and think twice before posting anything online. Once it is in cyberspace, it's there forever.

*Draw the computer's screen and follow the line to see which cord needs to be plugged in to the wall.*

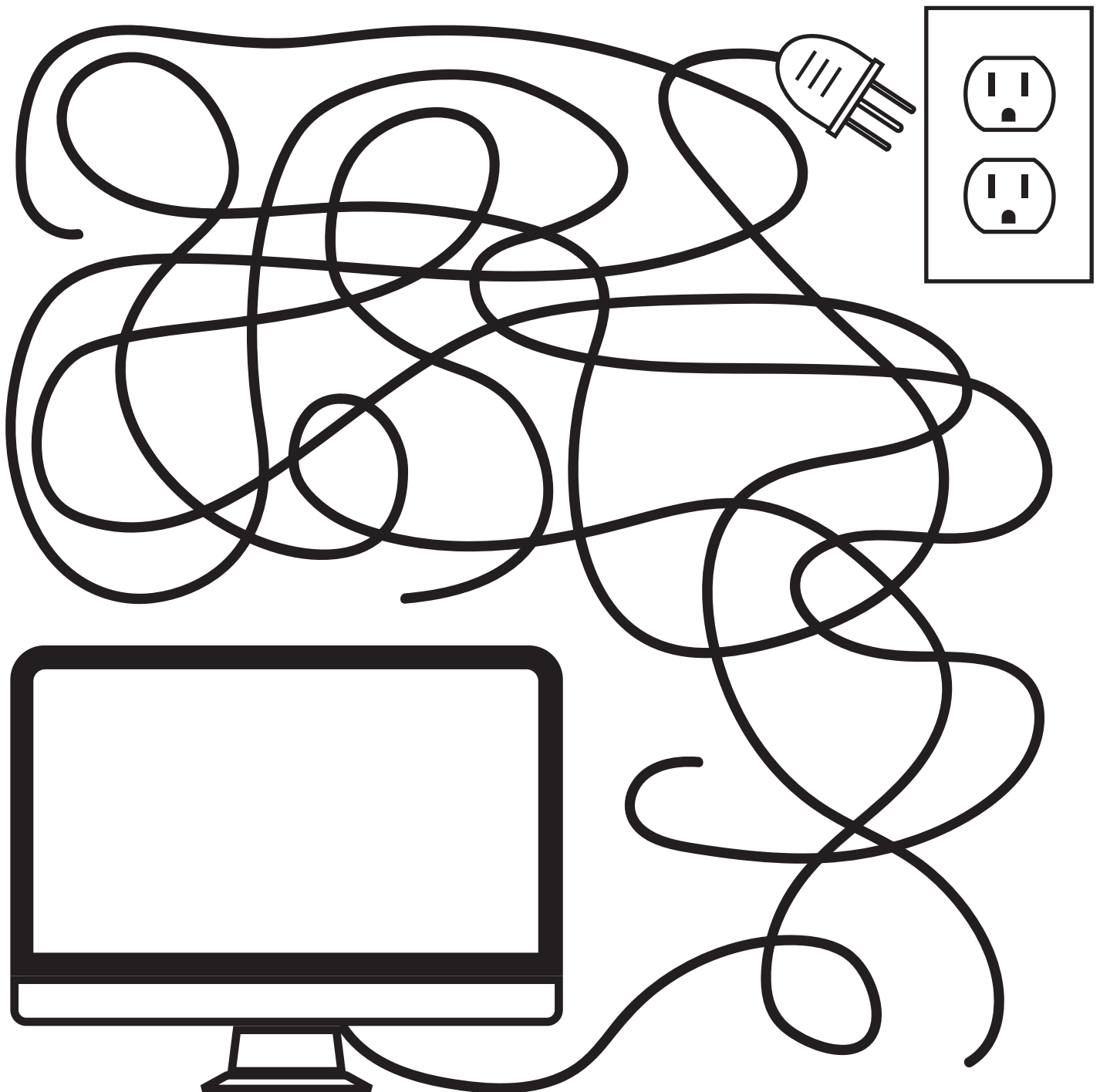

# Police Help Me

Police Officers of all shapes and sizes, male or female, are trained to help with emergencies, solve crimes, and protect you. They know first aid and rescue tactics because they are often the first ones to arrive where people are sick or injured. You can always ask a Police Officer for help if you are in trouble, scared, or lost.

*Color these police officers.*

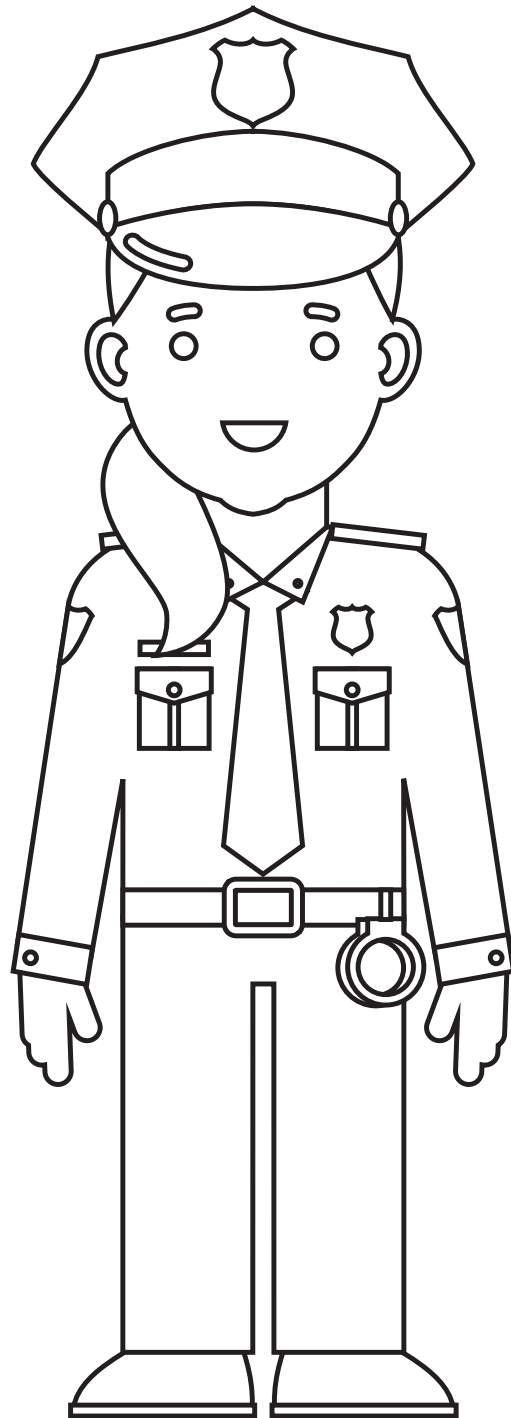
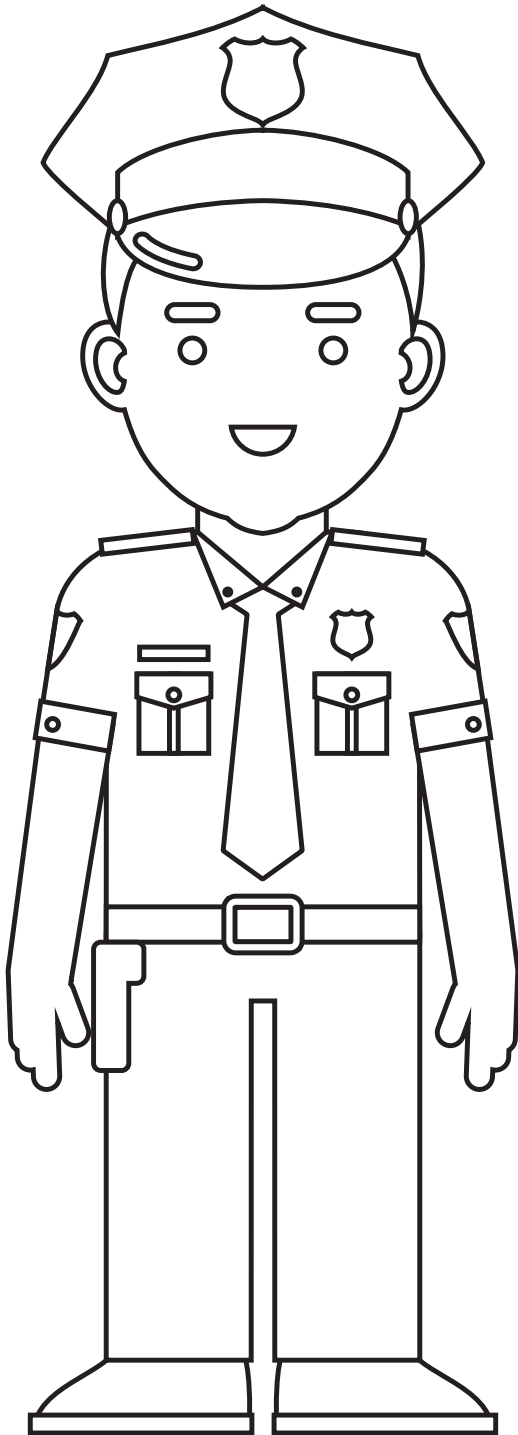



# Fired Up

Fire can be a scary thing to talk about because it is dangerous and can hurt people badly, but being prepared and knowing what to do during a fire can help save lives. *Fire up your brain to fill in the blanks of this crossword puzzle.*

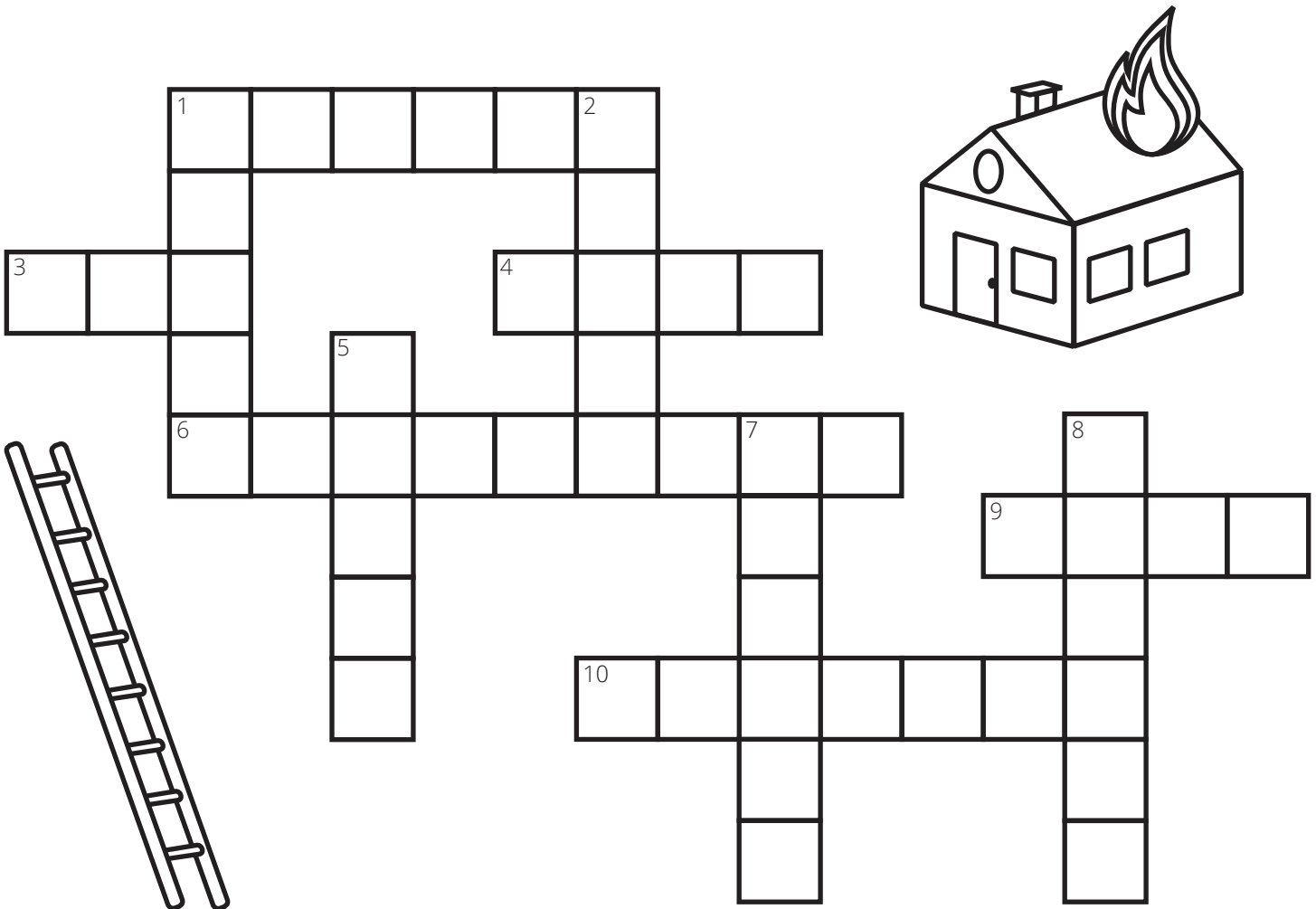

## Across

1. In case of fire, never use the elevator. Always take the \_\_\_\_\_.
3. Know \_\_\_\_ ways out of every room.
4. "Stop, drop, and \_\_\_\_\_."
6. Dial 9-1-1 in case of \_\_\_\_\_.
9. Practice your family escape \_\_\_\_\_ every month.
10. A fireman may use this to reach the upper floors of a building.

## Down

1. Never touch a hot \_\_\_\_\_.
2. If there's a fire, crawl on your hands and knees to avoid breathing this in.
5. You should \_\_\_\_\_ cook with out an adult's help.
7. Blow this out before leaving the room.
8. Smoke \_\_\_\_\_ should be tested every month.

TEXAS A&M ENGINEERING

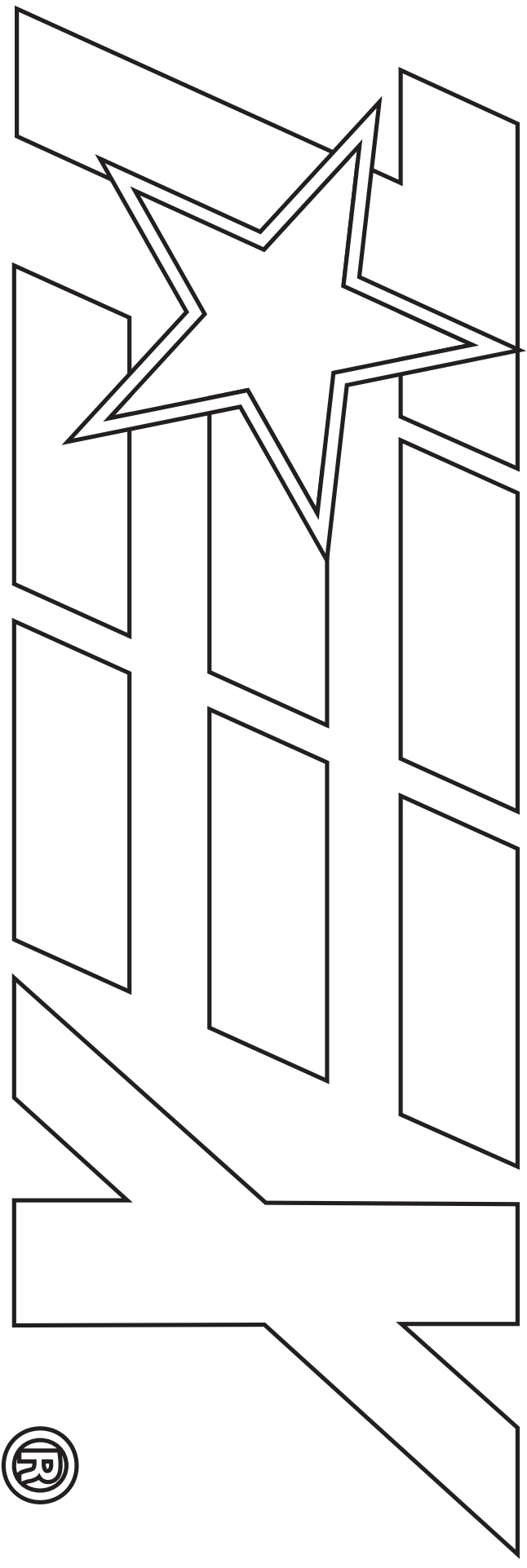

---

EXTENSION SERVICE



